

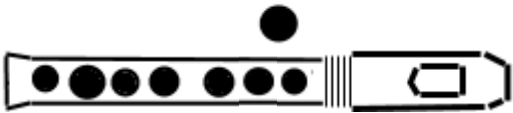









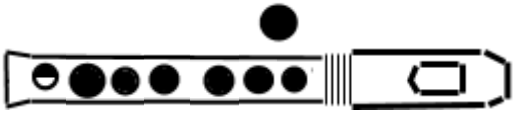





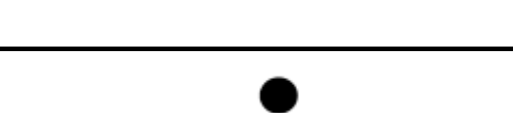





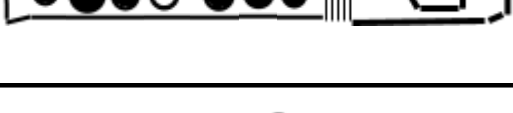



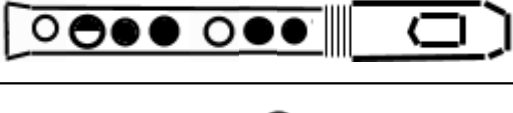





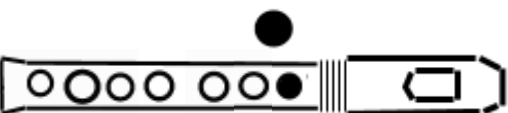

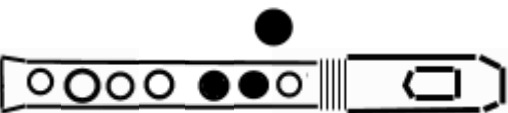
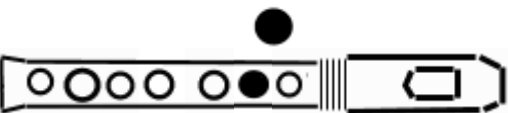
# Blockis Blockflötengriffe

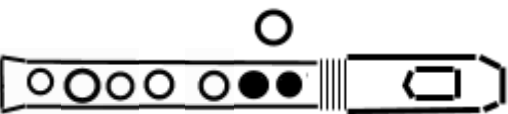
-- Kunath, Jo (DE) -- Sternenföte -- Sopran -- Deutsche Griffweise

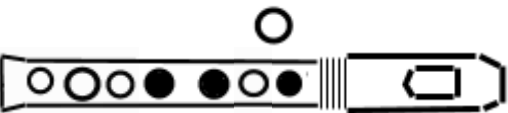
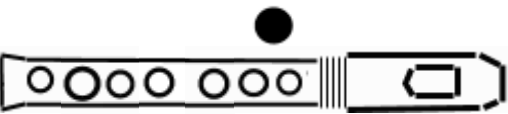
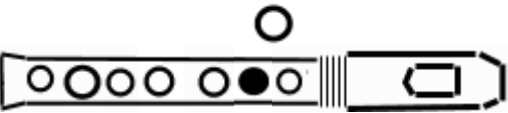
C 1. Oktave			C 1. Oktave
Cis/Des 1. Oktave			Cis/Des 1. Oktave
D 1. Oktave			D 1. Oktave
Dis/Es 1. Oktave			Dis/Es 1. Oktave
E 1. Oktave			E 1. Oktave
F 1. Oktave			F 1. Oktave
Fis/Ges 1. Oktave			Fis/Ges 1. Oktave
G 1. Oktave			G 1. Oktave
Gis/As 1. Oktave			Gis/As 1. Oktave
			
			

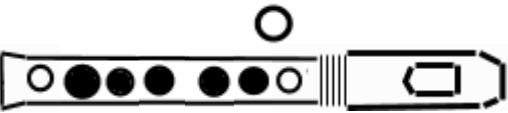

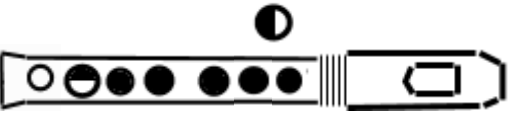

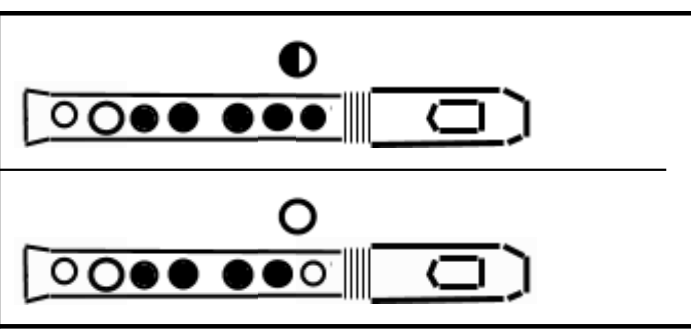
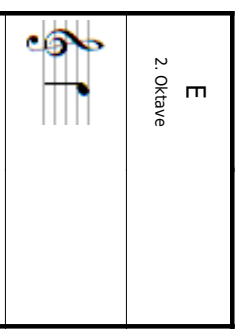
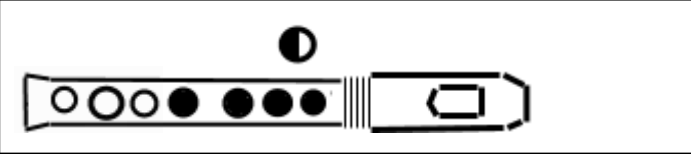
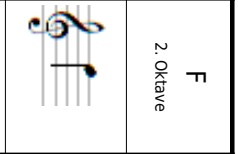
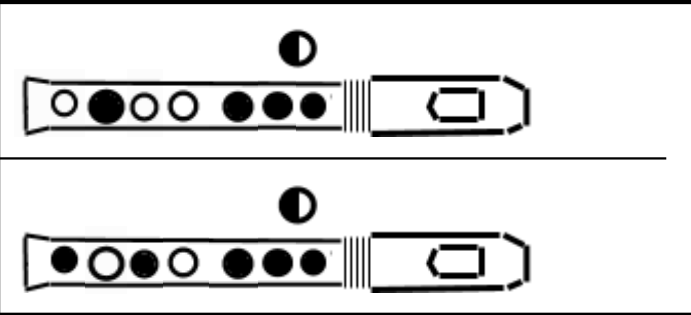
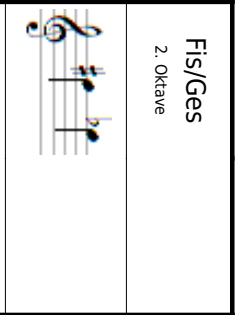
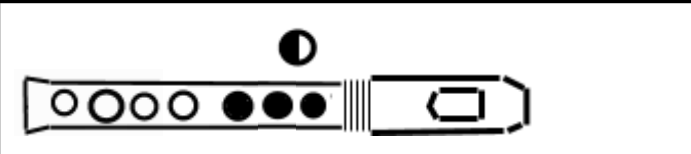
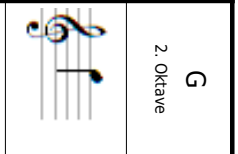
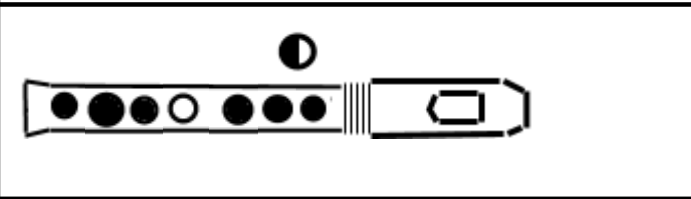
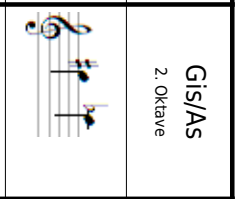
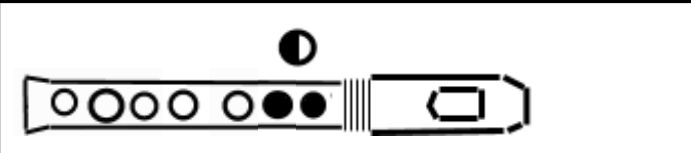
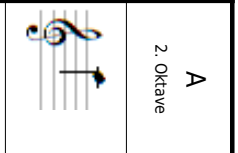
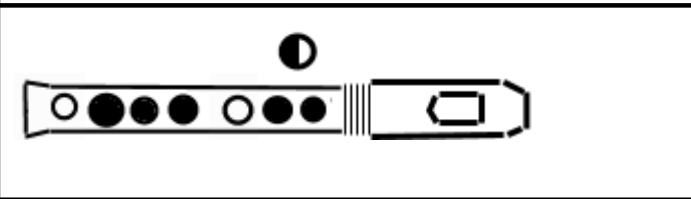
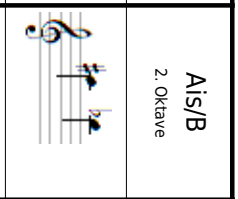
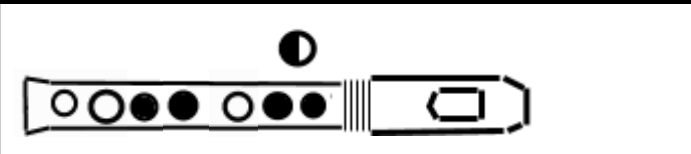
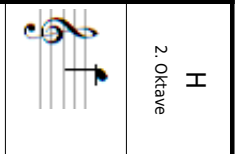
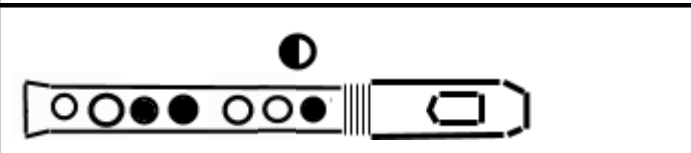
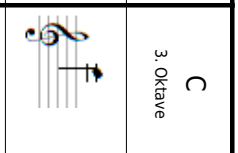
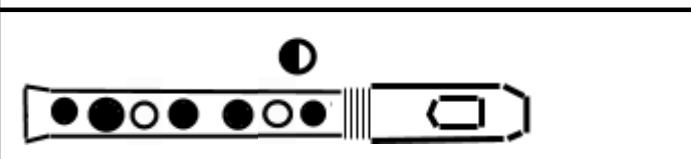
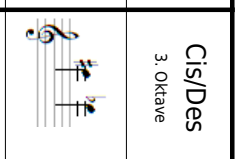

-- Kunath, Jo (DE) -- Sternenföte -- Sopran -- Deutsche Griffweise

<p>A 1. Oktave</p>			 <p>A 1. Oktave</p>
<p>Ais/B 1. Oktave</p>			 <p>Ais/B 1. Oktave</p>
			
<p>H 1. Oktave</p>			 <p>H 1. Oktave</p>
			
<p>C 2. Oktave</p>			 <p>C 2. Oktave</p>
<p>Cis/Des 2. Oktave</p>			 <p>Cis/Des 2. Oktave</p>
			
			
<p>D 2. Oktave</p>			 <p>D 2. Oktave</p>
<p>Dis/Es 2. Oktave</p>			 <p>Dis/Es 2. Oktave</p>
			

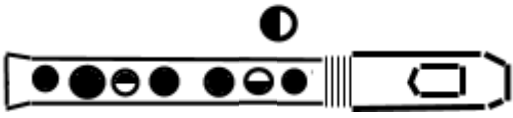
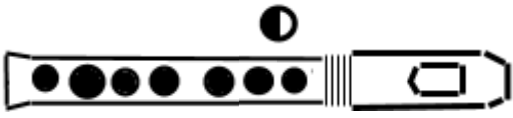
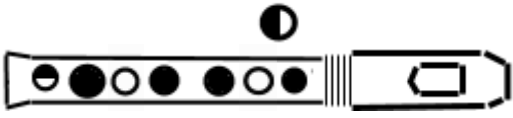
-- Kunath, Jo (DE) -- Sternenföte -- Sopran -- Deutsche Griffweise

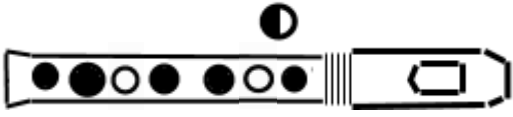
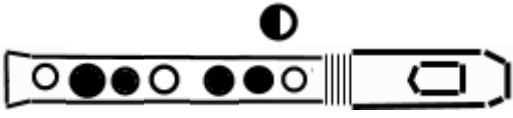
<p>E 2. Oktave</p>		
<p>F 2. Oktave</p>		
<p>Fis/Ges 2. Oktave</p>		
<p>G 2. Oktave</p>		
<p>Gis/As 2. Oktave</p>		
<p>A 2. Oktave</p>		
<p>Ais/B 2. Oktave</p>		
<p>H 2. Oktave</p>		
<p>C 3. Oktave</p>		
<p>Cis/Des 3. Oktave</p>		

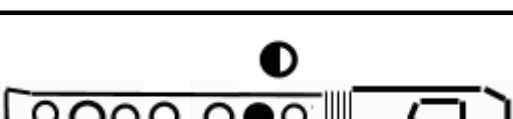
-- Kunath, Jo (DE) -- Sternenföte -- Sopran -- Deutsche Griffweise

					
					
D 3. Oktave				D 3. Oktave	
					
Dis/Es 3. Oktave				Dis/ES 3. Oktave	
E 3. Oktave				E 3. Oktave	

- >>> Der erste Griff ist der Hauptgriff, die weiteren sind Ersatz- und Nebengriffe.
- >>> Gefüllter Kreis unter dem Fußstück: Untere Schallöffnung mit dem Knie schließen.

(FPDF/DejaVu)de-2022-07-05 [74.36/t161/]