

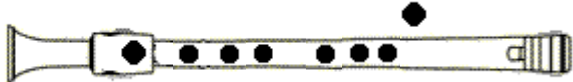



























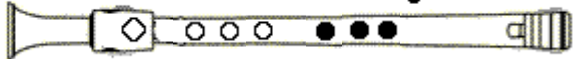





Blockis recorder fingerings

-- Renaissance fingerings -- Soprano

C 1st octave				C 1st octave
C#/Db 1st octave				C#/Db 1st octave
D 1st octave				D 1st octave
D#/Eb 1st octave				D#/Eb 1st octave
				
				
E 1st octave				E 1st octave
F 1st octave				F 1st octave
				
				
F#/Gb 1st octave				F#/Gb 1st octave
				
				

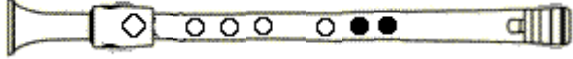







-- Renaissance fingerings -- Soprano

<p>G 1st octave</p>			 <p>G 1st octave</p>
<p>G#/Ab 1st octave</p>			 <p>G#/Ab 1st octave</p>
			
			
			
			
			
			
			
<p>A 1st octave</p>			 <p>A 1st octave</p>
<p>A#/Bb 1st octave</p>			 <p>A#/Bb 1st octave</p>

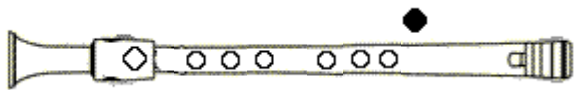
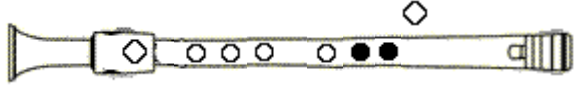

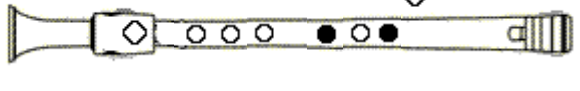

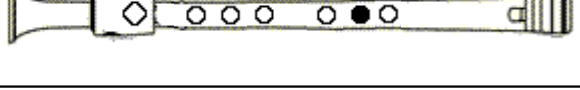

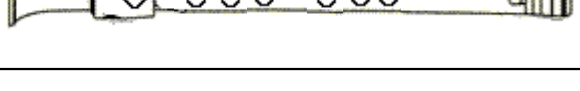
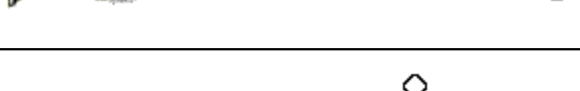
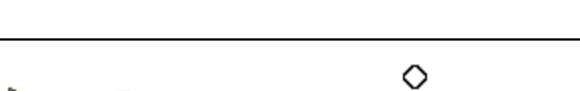
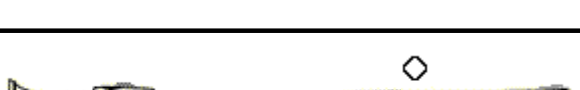
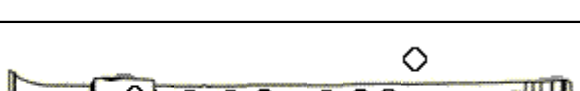
-- Renaissance fingerings -- Soprano

<p>B 1st octave</p>		
<p>C 2nd octave</p>		
<p>C#/Db 2nd octave</p>		

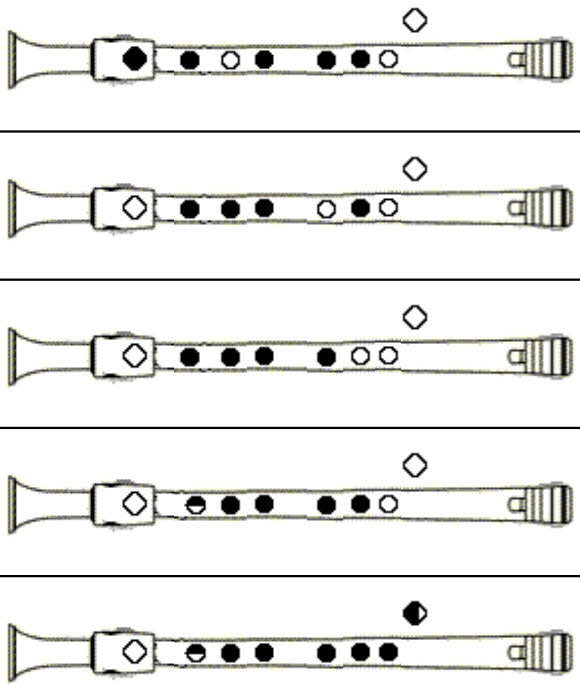
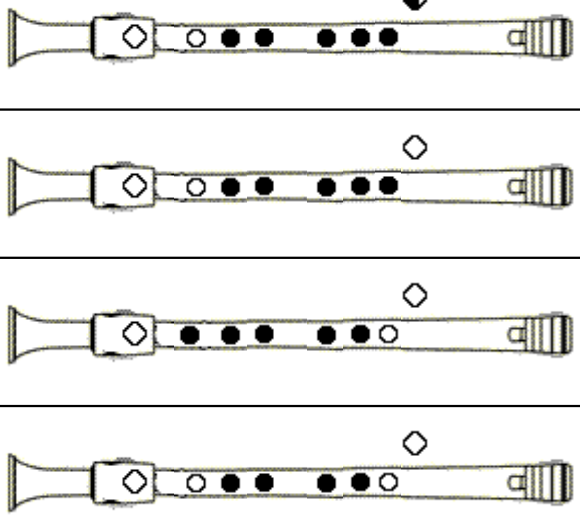

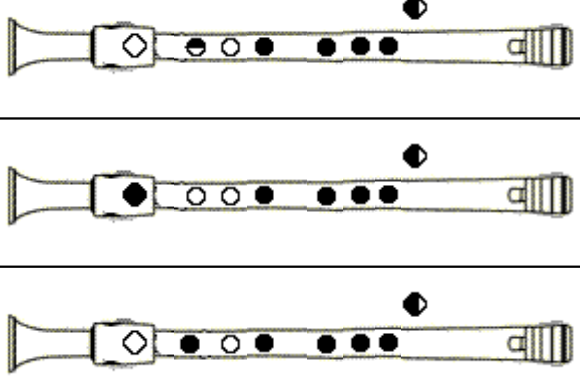

-- Renaissance fingerings -- Soprano

	<p>D 2nd octave</p> 	<p>D#/Eb 2nd octave</p> 
		
		
		
		
<p>D 2nd octave</p>	<p>D 2nd octave</p>	<p>D#/Eb 2nd octave</p>



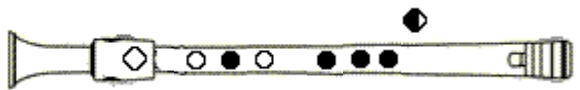

-- Renaissance fingerings -- Soprano

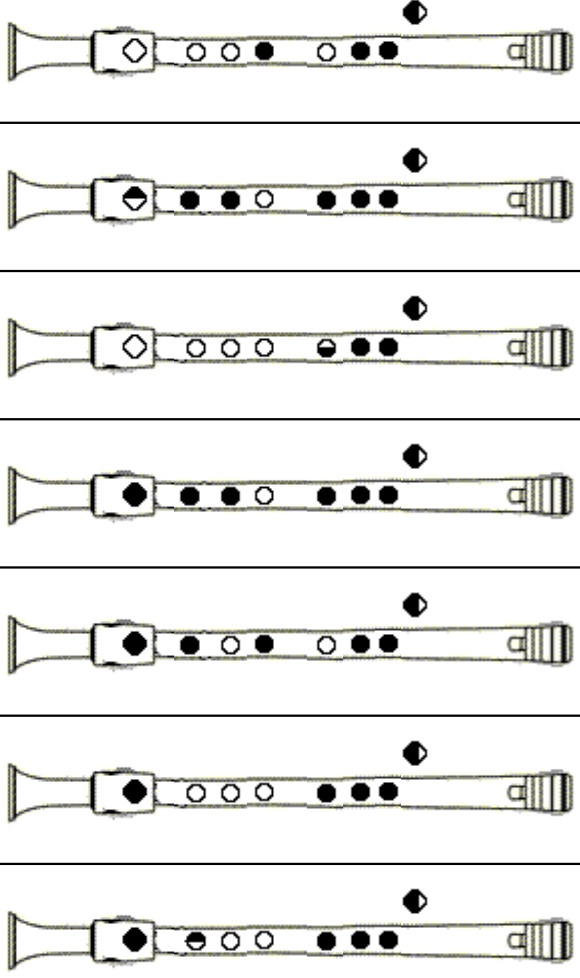
		
<p>E 2nd octave</p>		
<p>F 2nd octave</p>		
<p>F#/Gb 2nd octave</p>		



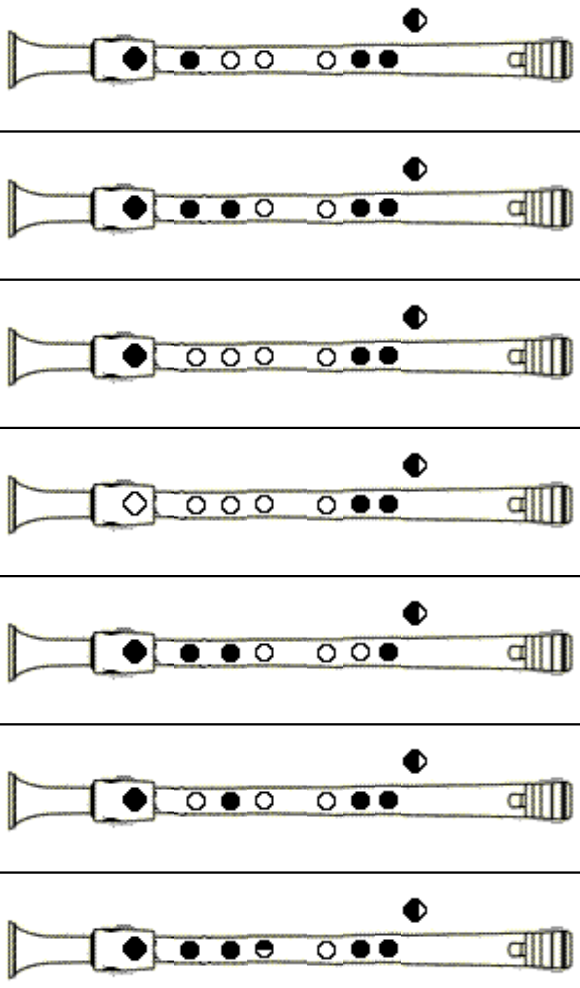

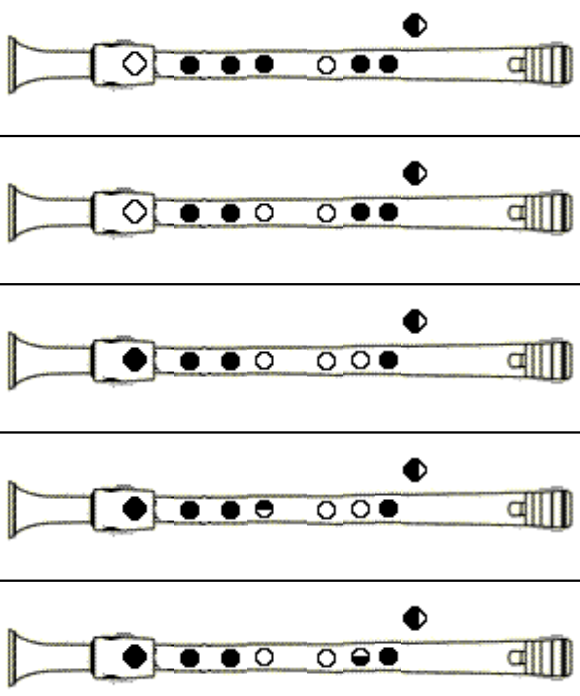

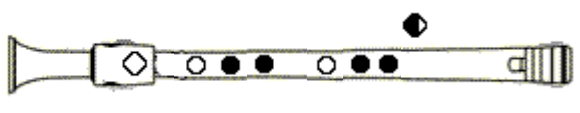



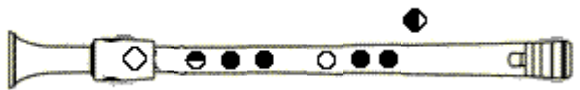
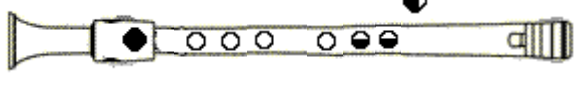
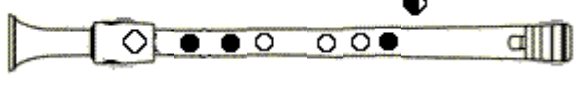

-- Renaissance fingerings -- Soprano

	<p>G 2nd octave</p> 	<p>G 2nd octave</p> 
		<p>G#/Ab 2nd octave</p> 

-- Renaissance fingerings -- Soprano

<p>A 2nd octave</p> 		<p>A#/Bb 2nd octave</p> 		<p>A 2nd octave</p>
<p>B 2nd octave</p> 		<p>B 2nd octave</p>		

-- Renaissance fingerings -- Soprano

	 <p>C 3rd octave</p>	 <p>C#/Db 3rd octave</p>	 <p>D 3rd octave</p>
  	    	  	 

-- Renaissance fingerings -- Soprano

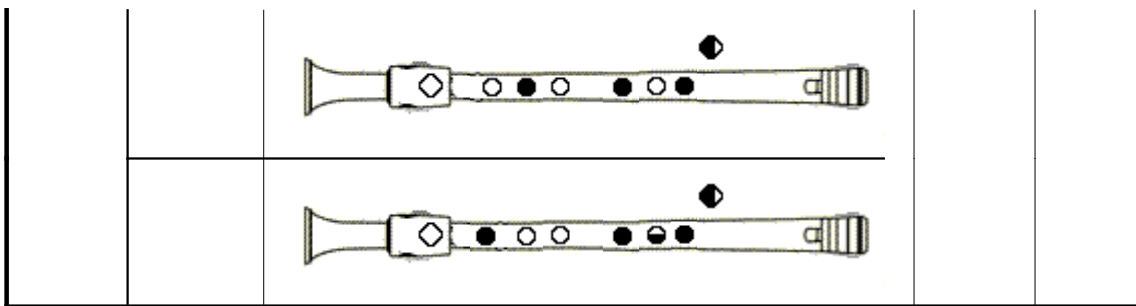

>>> The first fingering is the recommended fingering, the others are alternative fingerings.

(FPDF/DejaVu)en-2021-03-06 [74.36/t161/]